

**THE GIGRIG.COM**



# MORE OR LESS MANUAL

## CONTENTS

1. Introduction
2. Connections
3. Using More or Less With An Expression pedal
4. Using More or Less with CV
5. Settings
6. Expression Pedal Curves
7. Expression Curve Switches
8. Signal Chain Examples
9. FAQ's
10. Technical Specifications

## 1. Introduction

The GigRig More Or Less is an innovative remote amplitude control module that enables you to set up an expression pedal as a volume control, a boost, an under driver, and active splitter. You can control it with CV messages. More Or Less is internally balanced for exceptional audio quality, internally isolated with a +/- 18V giving you huge amounts of headroom with dip switches enabling you to choose the perfect curve for your expression pedal.



## 2. Connections

**SIGNAL INPUT:** Plug your guitar or audio source in here.

**MAIN OUTPUT:** The main effected output.

**AUX OUTPUT:** This output is a direct split from the input.

**EXP/CV INPUT:** Plug your expression pedal in here to use as a volume control. You can use this input to connect a Control Voltage. You use this connection for the TheGigRig FSL Remote Footswitch that simply flip/flops between the heel and toe values.

**POWER:** Plug your 9V DC power in here. MORE OR LESS will operate on anything from 9 to 30V DC. PLEASE NOTE, using a supply higher than 9V will not give any more headroom.

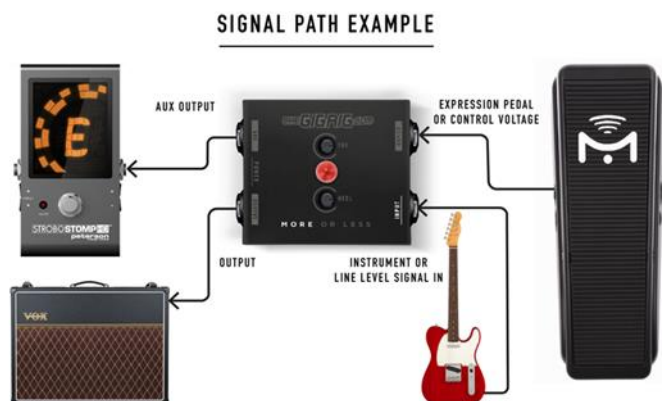

### 3. Using MORE OR LESS with an Expression Pedal

Used with an expression pedal the More Or Less is turned into a remote volume pedal. There is no audio in the TRS cable connection between the expression pedal and the More Or Less so use long TRS cables with no fear of signal degradation. More Or Less can even sit in the effects loop of your amp so you can control the volume of your amp remotely. The expression pedal will need the wiper of the expression pot to be connected to the RING of the TRS connector. Expression pedals that do this out of the box include TheGigRig TGR1, Dunlop DVP4/5, DOD Mini Exp, MOOG EP-3.

### 4. Using More or Less with CV

The More or Less operates with a unipolar CV signal between +1V to +5V's. The More or Less reacts in an inverse fashion eg. 1V = Maximum boost, 5V = Maximum Cut. When in CV mode, the trimmer pot on the top of the More or Less is not operational.

To enable CV mode;



To enable CV mode – this switch must be in the on position

## 5. Settings

### HEEL AND TOE

The Heel and Toe values of More Or Less enable you to set up your expression pedal to work as either a standard volume pedal, a boost, an underdrive.



### LED INDICATOR



As you sweep through the volume range with your expression pedal the LED indicator will let you know if you are boosting, attenuating or at unity.



## 6. Expression Pedal Curves

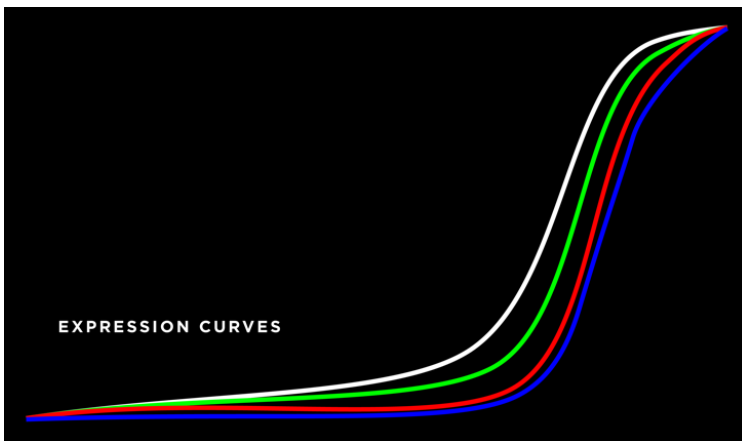





On the bottom of the More Or Less circuit board (accessible by undoing the screws on the bottom of More Or Less) are a pair of switches giving you access to different expression pedal curves.

Depending on the expression pedal you use, you may want a different sweep.

More Or Less' default setting is both internal curve switches in the OFF position.

## 7. Exp Curve Switches

	OFF/OFF - WHITE CURVE (Standard)
	OFF/ON - GREEN CURVE
	ON/OFF - RED CURVE
	ON/ON - BLUE CURVE

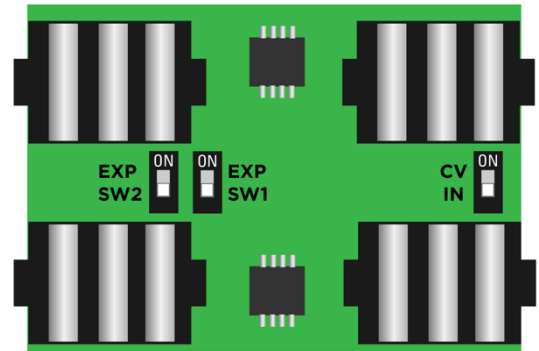

### CONTROL VOLTAGE

More Or Less can receive a Control Voltage or CV to control the level remotely. This is a great option to send the More Or Less a sequenced CV for programmed tremolo sounds.

To receive control voltages, ensure that the CV switch on the right is turned to the ON position.

## 8. Signal Chain Examples

### 1. FIRST IN SIGNAL CHAIN

With More Or Less the first in the signal chain, it acts as a master input gain control. Depending how you have it set, it will boost or reduce the input level to your effects.

### 2. AFTER GAIN STAGES, BEFORE DELAY

Set up like this, More Or Less will act as a master volume control for gain stages so will not change the tone of your overdrives, but will control the input level into your time based effects, delays, reverbs.

### 3. END OF SIGNAL CHAIN

In this scenario, More Or Less becomes a master volume for the entire signal chain.

## 9. FAQs

Can I use any expression pedal?

As long as the expression pedal is 10K and the centre pin of the potentiometer (wiper) is connected to the RING of the TRS cable. Expression pedals that do this out of the box include TheGigRig TGR1, Dunlop DVP4/5, DOD Mini Exp, MOOG EP-3.

Is it buffered?

Yes, More Or Less is buffered – high input impedance (680K $\Omega$ ), low output impedance (100 $\Omega$ ).

What's the best way to attach More Or Less to my pedalboard?

We recommended using pedalboard tape to attach More Or Less to a Loop Velcro or a dry flat surface.

Is there any benefit to using a higher voltage for more headroom?

No, voltages are fixed internally @ +/- 18Vdc. Using a higher voltage to power More Or Less will simply reduce the current needed without changing the headroom.

How do I bypass More Or Less?

Simply unplug the TRS cable from the EXP input and More Or Less will be a high quality unity gain buffer.

Can I change the curve of my expression pedal?

Yes, via the EXP Curve switches on the bottom of the circuit board.

To access the bottom of the PCB simply loosen the in/out sockets and undo the screws on the side of the unit.

## 10. Technical Specifications

Input Voltage: 9-24Vdc 2.1mm centre negative

Current Draw: 150mA @ 9Vdc

Audio is internally balanced

Power is internally isolated +/-18V

Input Impedance: 680K

Output Impedance: 100 Ohms

Attenuation:

Boost:

Control Voltage: 0~5V

Dimensions: 74.5Lx57.3Wx38.6Dmm (2.9Lx2.3Wx1.5D")

WEIGHT - 0.109kg / 0.24lbs

Safety: The GigRig More Or Less is designed for indoor use only - Don't get it wet

## 11. Warranty

The GigRig warrants the product to be free from defects in material and workmanship for a period of 2 years from the original date of purchase.

If the product fails within the warranty period, The GigRig will repair or, at our discretion, replace the product and cover the cost of return shipping to the original purchaser. This warranty covers defects in manufacturing discovered while using this product as recommended by The GigRig. This warranty does not cover loss or theft, nor does the coverage extend to damage caused by misuse, abuse, unauthorized modification, improper storage, lightning, or natural disasters.

Damage caused by any of the above circumstances may result in a non-warranty repair fee. Legal: In the case of malfunction, the purchaser's sole recourse shall be repair or replacement, as described in the preceding paragraphs. The GigRig will not be held liable to any party for damages that result from the failure of this product. Damages excluded include, but are not limited to, the following: lost profits, lost savings, damage to other equipment, and incidental or consequential damages arising from the use, or inability to use this product.

In no event will The GigRig be liable for more than the amount of the purchase price, not to exceed the current retail price of the product. The GigRig disclaims any other warranties, express or implied. By using the product, the user accepts all terms herein.

**Disposal:** TheGigRig contains no batteries or Lead. Return the unit to TheGigRig Ltd for disposal or use standard disposal for electrical equipment recommended in your country. Do not dispose of electrical equipment in household waste!

TheGigRig is protected by copyright, moral rights, patent and design registration.

Patent Granted GB2405987

USA Patent Pending US10/937,997 Design Registration # 3014412

'GigRig' is a stylized trademark. No 2343300

Any individual or company found copying the functionality, look or feel, circuits, circuit function or software functions for commercial gain will be liable for legal action. Licenses may be granted to non-competing companies.

The GigRig and its Power supply are RoHs compliant.

Tested and compliant to EN 60950 safety standard.

The power supply is approved to all USA and European

Regulations including UL. See separate instructions supplied with the power supply

